

**STACK
STACK
STACK**

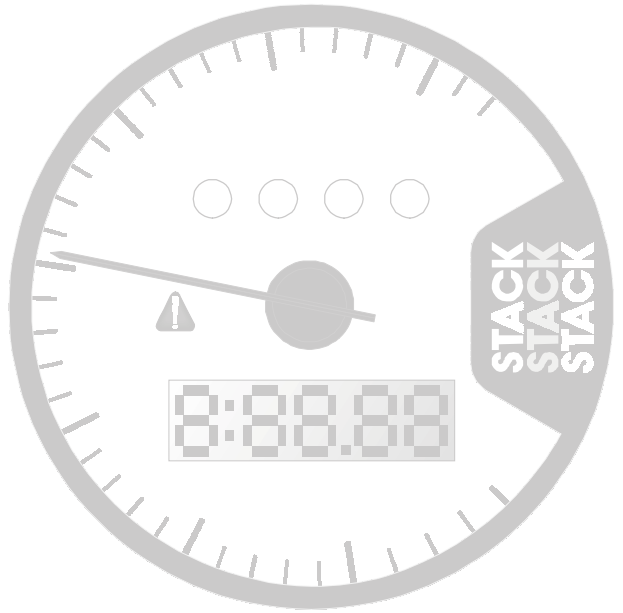

Model ST700 Dash Display System

IMPORTANT

The ST700 Dash Display System is supplied with its Demonstration Mode active.

Connecting power will start the Demonstration Mode.

Change the cylinders setting as instructed on page 53 to disable the Demonstration Mode.

Quick Start

1. Install the ST700 Dash Display System and connect it to the switched battery circuit, for example the ignition (B+) and the battery negative (B-).
2. Install and connect the controls (following the instructions that start on page 13).
3. Connect the ST700 Dash Display System 'ES' wire to the ignition low tension circuit.
4. Connect the sensors supplied with your system.
5. Turn on the ignition.
6. Use the Demonstration Mode to check that the ST700 Dash Display System is functioning normally.
7. Take the ST700 Dash Display System out of its demonstration mode by changing the setting for the number of cylinders. See page 53 for instructions.
8. Use the Driver button to select the display layers described on page 32.
9. Use the Rotary control to select the Memory Review and Setup modes as described on page 44.
10. Use the rotary control to set up the ST700 Dash Display System.

CONTENTS

CONTENTS	1
INTRODUCTION	3
How to use this manual	5
Safety Issues	6
Unpacking and Inspection	7
INSTALLATION	8
Product Installation	8
Wiring Harness	9
ST700 Dash Display System Display	12
Controls	13
Engine Speed Measurement	14
Lap Timing Sensor option	16
Trackside I.R. Beacon (optional)	18
Manual Lap Timing (optional)	20
Wheel Speed Sensor	21
Pressure Sensor options	23
Oil pressure switch	25
Temperature Sensor options	25
Battery connection	27
OPERATION	28
Switch functions	28

Power-on the ST700 Dash Display System	31
Changing the display layers	32
Lap and Split Times	37
Manual Split Timing Setup	39
Automatic Split Timing Setup	41
Hillclimb and Sprint Operation	42
MEMORY AND SETUP	43
Memory review features	44
Setup mode	47
TESTING	60
MAINTENANCE	62
Troubleshooting	62
Specification	72
Contact details	75
INDEX	79

INTRODUCTION

Thank you for selecting the ST700 Dash Display System from Stack as your choice of vehicle's instrumentation—we feel sure that you are going to be delighted by your purchase!

The ST700 Dash Display System is a superb quality instrument that integrates a number of performance functions into a single display product. The functions enabled on your unit are specific to your selection. However, any ST700 Dash Display System can be upgraded to include any combination of the available functions.

Functions on all ST700 Dash Display Systems:

- Engine RPM—with maximum RPM telltale
- Any two of pressure and temperature sensors
- Voltmeter gauges
- Vehicle speed (user-selectable MPH or km/h)
- Peak value recall and intelligent alarm on all monitored engine parameters
- Adjustable backlighting intensity
- Programmable sequential shift lights with four selectable patterns and adjustable brightness
- User-configurable setting to suit most vehicles

Optional functions available:

- Odometer and tripmeter (user-selectable Miles or Kilometres)
- Lap and split-time memory
- Corner and maximum straight speed read-out
- User selectable acceleration and deceleration timer and ¼ mile time
- Plug-in lap timing and data acquisition options
- White or black dial face options offering a choice of RPM scales with optimised ranges

The ST700 Dash Display System requires a connection to the vehicle battery supply, the engine ignition system and the various sensors fitted to the vehicle to provide the full range of measurements.

If your ST700 Dash Display System includes the option to trigger lap times automatically, you will also require a vehicle-mounted infrared (IR) sensor and a track-side IR beacon.

Refer to the following section of this user guide for instructions to install the ST700 Dash Display System.



Depending on the model you have chosen, your ST700 Dash Display System might not include some of the features described in this user guide.

How to use this manual

This manual tells you how to:

Install the ST700 Dash Display System display instrument and its wiring harness

Install and connect the standard and optional sensors on a vehicle

Configure the ST700 Dash Display System for your vehicle

Operate and read the ST700 Dash Display System during and after a run

Throughout this manual, you will see the following symbol:



These are special or important notes and tips that you should read and understand.

Safety Issues

You must take note of the following safety advice when you install the ST700 Dash Display System on your vehicle:



Follow the instructions to attach all components of the system securely to the vehicle so that they do not vibrate loose and fall off.

The wiring harness supplied with the ST700 Dash Display System is certified for use in high temperature applications up to 105°C (221°F). Do not substitute wires that have a lower temperature rating than this. Contact Stack for advice if you are in any doubt.

Route all wires and the wiring harness so they do not snag against any moving parts of the vehicle.

Do not apply sharp bends or other severe stresses to the wiring harness.

Avoid positioning the sensors or their wires close to any sources of intense heat or vibration or close to the leads of the ignition HT or fuel injection systems.

Use cable clips to secure the wiring harness.

Use suitable glands or grommets to protect the wiring harness where it passes through vehicle bulkheads or panels.

Unpacking and Inspection

When you unpack your ST700 Dash Display System, check all the items against the packing list.

INSTALLATION

You do not need complicated tools or special training to install the ST700 Dash Display System. To gain the benefits of using this quality instrument all you need are a few basic workshop tools, the willingness to read and follow these instructions carefully and the time to complete each task in sequence.



Refer to the instructions between page 43 and page 59 for instructions to set up the ST700 Dash Display System display and alarm limits specifically for your vehicle.

Product Installation

The installation process begins when you start to install the wiring harness, the controls and the ST700 Dash Display System display. After you have completed these tasks, you can fit and connect the options and sensors included with your system. You may then connect the ST700 Dash Display System to the vehicle electrical supply.

You will need to cut a hole into the instrument panel to accept the ST700 Dash Display System instrument display. Choose a suitable position for it:

- Mount the ST700 Dash Display System display on the instrument panel so that the driver can see it easily, looking either through or over the steering wheel, as shown in Figure 1.

Figure 1: ST700 Dash Display System display location

- ❑ Position the ST700 Dash Display System display so that the driver can see it either square on or from a position slightly above.

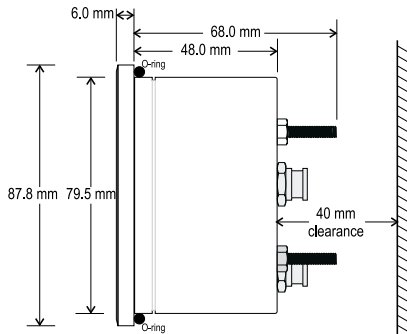
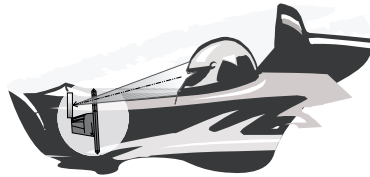

Figure 2: Overall dimensions

- ❑ Make certain there is sufficient space behind the instrument panel to accept the ST700 Dash Display System display. Allow additional space so that you may run and connect the wiring harness without the need to apply sharp bends to the harness.

Figure 2 shows the overall dimensions of the ST700 Dash Display System display, which fits into a standard 80 mm diameter hole.

Wiring Harness

Stack supplies a wiring harness to connect the ST700 Dash Display System within the vehicle. If you find that the standard wiring harness is unsuitable for installation on your particular vehicle, contact Stack or an

approved Stack agent for details of wiring harness extensions. Labels identify each wire in the harness shown in Figure 3.

1. Identify all the relevant connectors of the wiring harness.
2. Plan the location of all the component parts of your ST700 Dash Display System and decide the best layout to use when you install the wiring harness.



Note that your installation might not use all the cables that exist in the harness. You should tie back and protect all unused connectors.

3. Begin at the instrument panel where you will install the ST700 Dash Display System display. Lay the wiring harness into the vehicle, with the cable branches running to their appropriate locations. Allow sufficient slack in the harness so that you can connect it to the ST700 Dash Display System *before* you insert the display into the instrument panel.



You should route all cables to be no closer than 75 mm (3 inches) to the ignition HT leads or the distributor cap. Do not run cables close to sources of intense heat.

4. Fit cable glands to protect the cables where they pass through bulkheads or panels. This is particularly important when you pass cables through carbon fibre partitions, which can wear through them easily.

Figure 3: Electrical connections

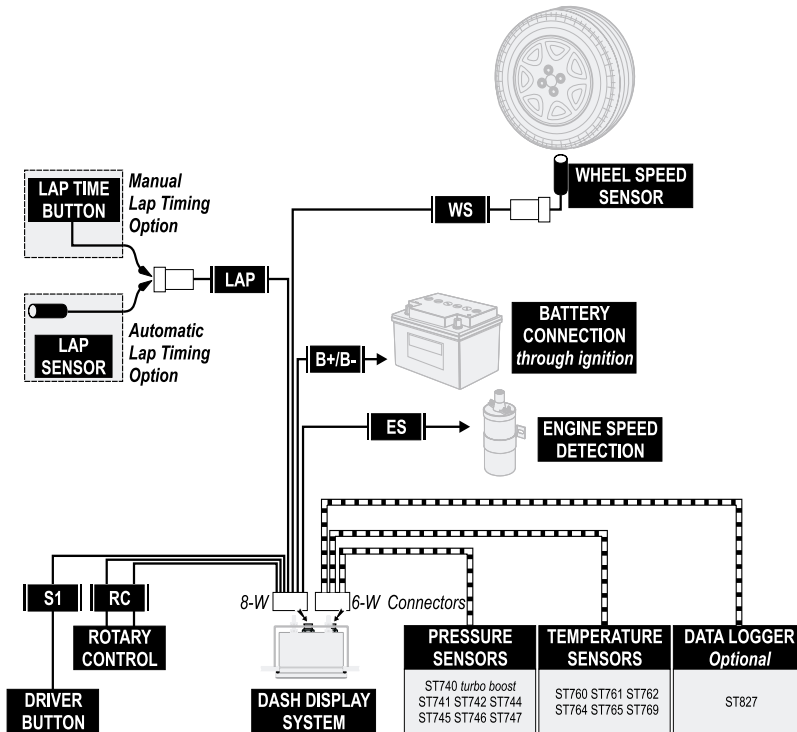

Note: Pressure and temperature sensors can be connected to either port on the Dash Display System

ST700 Dash Display System Display

1. Connect the wiring harness to the ST700 Dash Display System display. There are two connection ports on the back of the display, but you can insert the 8-way connector only into one of them. Do not try to force the connector into the incorrect port. Tighten the locking collar by hand. The second, 6-way, port allows you to connect the optional pressure and temperature sensors and an optional data logger module.

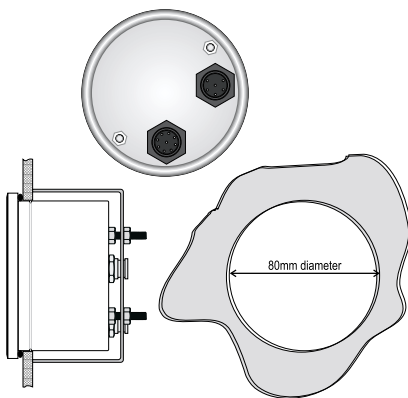

Figure 4: Display mounting

2. Fit the ST700 Dash Display System display into the instrument panel using the supplied O-ring.
3. Reach behind the instrument panel and position the securing bracket as shown in Figure 4. Tighten the lock nuts to fix the ST700 Dash Display System display into position.

Controls

The ST700 Dash Display System includes three controls:

- ❑ **Driver button**—this is a normally–open spring–loaded switch that closes when pressed and opens when released.
- ❑ **Rotary control**—this is a combined push button and rotary selector.
- ❑ **Lap button (optional)**—this is a normally–open spring–loaded switch option that closes when pressed and opens when released.

For convenience, you should install the controls where the driver may operate them easily. An ideal installation for the Driver button and for the optional Lap button is on the steering wheel within easy reach of a thumb.

Install the rotary control where it is possible to operate it conveniently while viewing the ST700 Dash Display System display.

1. Drill holes or install brackets to support the controls in the locations you have selected for them. The hole dimensions and tightening torques are:

Rotary control: M7 clearance (7.2 mm diameter) with the control tightened to 1.2 Nm (12 kgf.cm or 0.9 lbf.ft)

Driver button: 12.2 mm diameter with the control tightened to 1.5 Nm (15 kgf.cm or 1.1 lbf.ft)

2. Connect the correct cables of the harness to each control.

Engine Speed Measurement



This connection is dependent on your ignition system. You should read these instructions carefully and make certain you have identified the correct connection point before you begin.

To measure engine speed you must make the correct connections between the ST700 Dash Display System and the vehicle ignition system. Contact Stack for advice if you have a complicated ignition system.

Table 1: Connection to the ignition system

Ignition System	Connection point (Orange wire)
Coil and Points	Coil negative (Low tension)
HEI Systems	Coil negative (Low tension)
Magneto (external or internal)	Ground switch terminal (magneto side)
MSD	Tachometer output
Magneto CD (2-stroke)	Use HT pick up (ST697)

If you cannot use any of these engine speed connections, you may use the optional Stack ST697 HT pick-up to get a signal from an ignition lead.

Standard contact breaker system

Connect the 'ES' wire of the harness to the negative contact breaker terminal on the coil as shown in Figure 5.

Electronic ignition connection

Connect to the electronic ignition of the vehicle as indicated in Figure 6.

If your ST700 Dash Display System includes the Lap Timing sensor, the Wheel Speed sensor or any pressure or temperature sensors, follow the instructions between page 16 and page 27 to install them. Otherwise, turn to page 27 for instructions to connect your ST700 Dash Display System to the switched battery circuit of your vehicle.

Figure 5: Standard contact breaker connection

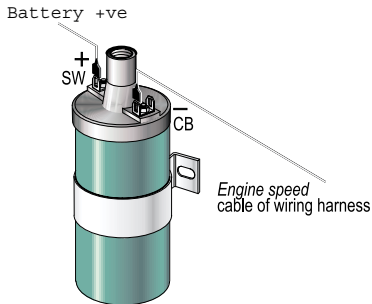
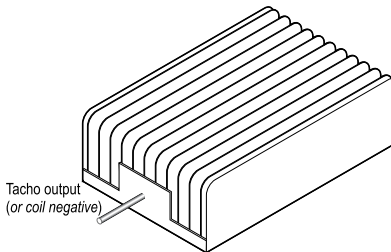

Figure 6: Connection to electronic ignition



Lap Timing Sensor option

The lap-timing sensor triggers the ST700 Dash Display System automatically each time the vehicle passes the Stack infrared (IR) beacon at the side of the track.

1. Choose a location on the vehicle for the lap-timing sensor:

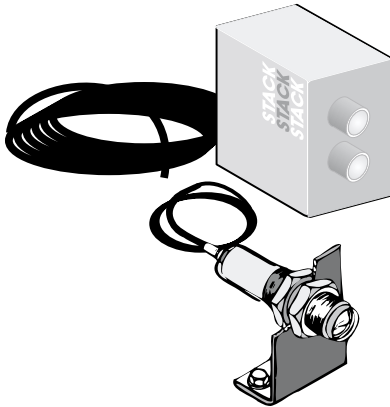

Figure 7: Lap timing beacon

- You must position the sensor to be horizontal and square to the vehicle axis.
- It must have a clear view of the trackside beacon, even when you overtake or are overtaken by other vehicles.
- Do not mount the sensor behind glass or Perspex.
- The sensor must be at the same height as the beacon.

As shown in Figure 8, you can adjust the height of the beacon to achieve this condition.

-
- ❑ You may need to have more than one possible location available for the lap-timing sensor on your vehicle to allow for the layout of different tracks. Consider installing one on each side of the vehicle.
 - ❑ Where the track has more than one trackside beacon, you may set up the ST700 Dash Display System to ignore additional IR beacons for a period after it senses the first beacon. This 'lap masking' feature prevents multiple triggering within each lap.
2. Attach the wire labelled 'LAP' of the harness to the sensor at the 4-way 'Sure-Seal' connector. Take care to assemble this connector in the correct orientation. Press the two halves of the connector fully together to ensure a good waterproof seal.

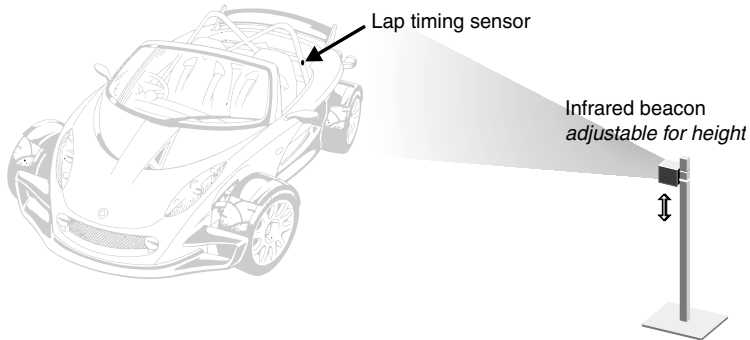

Use a rigid mounting bracket to attach the sensor to the outside of the vehicle where it can detect the signals from the trackside beacon. Use the two M18 × 1 mm threaded nuts to secure the sensor.

Figure 8: Infrared beacon alignment

Trackside I.R. Beacon (optional)



There must be only one Stack trackside beacon used on the track. Do not place your beacon half way around the track because this might inconvenience other users of Stack equipment.

If you have fitted the lap timing sensor to your vehicle, you will need to use the trackside IR beacon to trigger the sensor for each lap.

1. Choose a suitable location for the beacon:
 - Install the beacon as close as possible to the start/finish line, and at least 4 metres (12 feet) from other types of beacon.

- ❑ Set the height of the beacon to be level with the lap timing sensor on your vehicle. Set the beacon level so that it emits a horizontal beam.
 - ❑ Choose a position for the beacon between 2 and 30 metres (6 to 95 feet) from the vehicle as it passes within each lap.
 - ❑ Avoid locating the beacon where the sun is directly behind it. This is because the lap timing sensor will be unable to distinguish the signal from the beacon against the intense infrared background signal from the sun.
 - ❑ If you intend to use the beacon for extended periods in very hot, sunny conditions, protect it from direct sunlight.
 - ❑ Protect both transmitter lenses of the beacon from water spray. During wet conditions, fit a protective peak over the beacon. Do not cover the beacon, for example using a plastic bag.
2. You must supply the beacon with power from a convenient 12V DC source. A sealed lead–acid battery with a rating of at least 2.5 Ah is ideal for this purpose. From a fully charged condition, such a battery will provide continuous operation for approximately 15 hours.

Operation of the trackside beacon is simple:

1. The beacon begins to operate as soon as you connect a suitable DC supply.
2. There is a two–colour status LED on the beacon:

- ❑ The LED shows **green**—Battery voltage is adequate for normal operation.
- ❑ The LED shows **red**—The battery voltage is too low. Fit a fully charged battery.
- ❑ The LED is **off**—The battery is discharged or disconnected.

Manual Lap Timing (optional)

Optionally, instead of the automatic infrared timing described above, the ST700 Dash Display System can accept lap timing triggers from a 'Lap Timer' button located at a convenient position for the driver to operate. Instead of the IR sensor, the cable from the Lap Timer button connects to the LAP input as shown in Figure 3. To fit the manual lap timing option you will require the switch (ST517) and the wiring harness (ST918037).

With the manual lap timing option fitted, the driver must press the Lap Timer button as the vehicle crosses the start line.



Because manual lap timing requires a positive action from the driver, it is less accurate than the automatic lap timing option by IR sensor already described. Furthermore, because split timing also comes directly from the lap timing input, any errors in the lap timing will degrade the accuracy of split times. For these reasons, Stack does not recommend the use of manual lap timing.

Wheel Speed Sensor

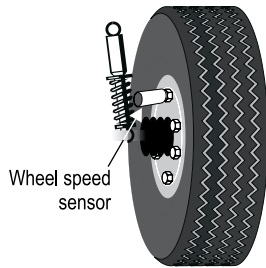

Figure 9: Wheel speed sensor

The Stack ST670 wheel speed sensor generates an electrical pulse for the ST700 Dash Display System whenever a ferrous target, such as a wheel bolt, passes close to its end. You must install the sensor so that it detects the wheel turning by a sequence of such targets.

You may also use the ST492 pulse amplifier to read signals (pulses) from an existing gearbox sensor. Refer to the separate instruction manual supplied by Stack for details of this module.

Once you have installed the wheel speed sensor successfully, the ST700 Dash Display System uses the pulses to measure the vehicle speed. You must set-up the ST700 Dash Display System correctly to use this information.

1. Select a suitable and convenient location for the sensor. For each wheel rotation, the sensor must detect at least one ferrous target (for example, a driveshaft bolt). Note that the sensor will not detect items such as alloy wheel spokes or other non-ferrous objects and you should not try to use these as targets.

- ❑ If possible, choose a wheel that experiences negligible wheel spin, lift or lock-up—for example, an undriven wheel.
 - ❑ Ideally, the targets should be equally spaced around the wheel so that, with a constant wheel speed, the electrical pulses occur at regular intervals.
 - ❑ To avoid excessive heating do not install the sensor too close to the brake disc or calliper.
 - ❑ Position the sensor no closer than 75 mm (3 inches) to ignition HT leads or sources of intense heat.
2. Make a suitable rigid bracket to support the sensor and attach it to the vehicle. Fit the sensor to the bracket. Do not over tighten the sensor—tighten the sensor to 1.2 Nm (12 kgf.cm or 0.9 lbf.ft). Use fibre washers to insulate the sensor from heat transmitted through the bracket.
 3. Adjust the clearance between the end of the sensor and the ferrous targets so that the gap is nominally $1.0 \text{ mm} \pm 0.5 \text{ mm}$ (0.040 ± 0.020 inches). Make certain there are no other objects passing within 4 mm ($\frac{3}{16}$ -inch) of the sensor when the wheel rotates.
 4. Attach the wire labelled 'WS' of the harness to the sensor at the 4-way 'Sure-Seal' connector. Take care to assemble this connector in the correct orientation. Press the two halves of the connector fully together to ensure a good waterproof seal.



When you power-on the system, a small light built into the back of the sensor will light up each time it senses a target. Ensure this light is visible when you fit the sensor so that you may use it to test the sensor.

The Stack ST669 wheel speed sensor is compatible with the ST700 Dash Display System and may be used if circumstances do not allow you to use the ST670. Contact Stack for details.

Pressure Sensor options

You may use pressure sensors to monitor the following conditions:

Table 2: Pressure sensors

Monitored condition	Stack Sensor types
Boost pressure	ST740
Fuel pressure	ST741, ST742, ST744, ST745, ST746, ST747
Oil pressure	ST744, ST745, ST746, ST747

Table 3: Pressure sensor ranges

Sensor type	Maximum pressure range
ST740 (solid state)	50 psi (3.5 bar)
ST741 ST742	30 psi (2 bar)
ST744 ST745 ST746	150 psi (10 bar)
ST747 (solid state)	150 psi (10 bar)



You may set up the ST700 Dash Display System to display pressure measurements using PSI or bar, and you may set the system to alert the driver if the monitored value triggers a pre-set alarm—refer to page 56 for relevant instructions.

1. Depending on the condition that you wish to monitor on your vehicle, choose a suitable location for the sensor:
 - Avoid mounting the sensor near sources of intense heat.
 - Do not mount the sensor closer than 75 mm (3 inches) to ignition leads, the distributor or the ignition coil.
 - If possible, avoid mounting the sensor directly on the engine block because excessive vibration will shorten its life expectancy.
2. Attach the sensor to its appropriate monitor point, if necessary using suitable pressure hose and fittings.

3. Connect the wiring harness to the sensor at the spade terminals.

Oil pressure switch

You may connect the engine oil pressure switch to the ST700 Dash Display System instead of a Stack pressure sensor. This switch will be 'open' when the oil pressure is high and will close when the oil pressure falls below its operating point and will cause the low oil pressure alarm to display. To use the engine oil pressure switch as an input to the system, select the option to use a switch from the Sensor 2 input menu (described on page 56). This will then mean that Display Layer 5 (described on page 34) will not be shown.

Temperature Sensor options

You may use temperature sensors to monitor the following conditions:

Table 4: Temperature sensors

Monitored condition	Stack Sensor types
Air temperature	ST765, ST769
Axle temperature	ST760, ST761, ST762,ST764, ST769
Differential temperature	ST760, ST761, ST762,ST764, ST769
Gear temperature	ST760, ST761, ST762,ST764, ST769

Table 4: Temperature sensors (Continued)

Monitored condition	Stack Sensor types
Oil temperature	ST760, ST761, ST762, ST764, ST769
Water temperature	ST760, ST761, ST762, ST764, ST769

Table 5: Temperature sensor ranges

Sensor type	Temperature range
ST760 ST761 ST762 ST764	-20 °C to 150 °C (0°F to 300 °F)
ST765	-30 °C to 140 °C (-20°F to 285 °F)
ST769	-30 °C to 150 °C (-20 °F to 300 °F)



You may set up the ST700 Dash Display System to display temperature measurements using °C or °F, and you may set the system to alert the driver if the monitored value triggers a pre-set alarm—refer to page 56 for relevant instructions.

- Depending on the condition that you wish to monitor on your vehicle, choose a suitable location for the sensor:
 - Avoid mounting the sensor near sources of intense heat.

- ❑ Do not mount the sensor closer than 75 mm (3 inches) to ignition leads, the distributor or the ignition coil.
 - ❑ Mount the sensor directly in the fluid line so that its end lies in the middle of the flow of fluid.
2. Attach the sensor to its appropriate monitor point.
 3. Connect the wiring harness to the sensor at the spade terminals.

Battery connection

The ST700 Dash Display System accepts power from the vehicle electrical system through the two cables labelled 'B+' and 'B-' in the wiring harness.

1. Connect the **black** 'B-' cable from the harness directly to the battery **negative** terminal.
2. Connect the **red** 'B+' cable of the harness to a fused supply from the battery **positive** terminal. The fuse rating for this line should be no higher than one amp. **This line should become 'live' only when you switch on the vehicle ignition.**

OPERATION

This section of the manual tells you how to use the ST700 Dash Display System.

You can access all the ST700 Dash Display System display functions by using the Driver button and the rotary control. This simple but effective method of operation allows the driver to operate the system with minimal distraction.

Switch functions

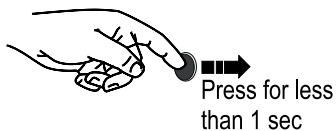

Figure 10: Driver button

- In **Normal mode**—Cycle through layers on the display.
- Clear pop-up message.

- In **Normal mode**—show peak values of the current display layer.
- While turning the rotary control in **Setup mode**—adjust the parameter in larger steps.

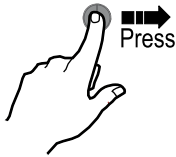

Figure 11: Rotary control

Press the rotary control:

- In **Normal mode**—Press for longer than 2 seconds to change to memory review and setup mode.
- When showing the speed layer, press for less than 1 second to switch between **odometer** and **trip meter**.
- With the trip meter showing, press for between 1 and 2 seconds to reset the trip meter.



Turn the rotary control:

- Turn the rotary control anticlockwise to set the display to night time illumination level for backlight and shift lights.
- Turn the rotary control clockwise to set the display to the preset daytime illumination levels.



Press and turn the rotary control:

- In **Memory Review and Setup mode**—cycle through the menu options.
- In **Setup mode**—Adjust the parameter.
- In **Lap Memory mode**—Cycle through the lap and split times.

Figure 12: ST700 Display features

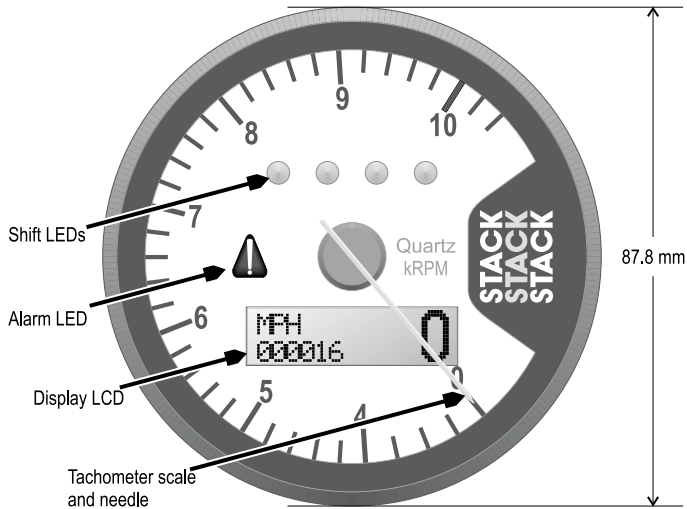

- Normal mode** is the normal operating condition of the ST700 Dash Display System. In this condition the system provides all available measurements and functions for the driver.
- Setup mode** allows you to configure the ST700 Dash Display System for your specific vehicle and driver requirements.
- Review mode** allows you to read the lap times and peak values stored in the ST700 Dash Display System memory.

Power-on the ST700 Dash Display System

Switch on the vehicle ignition. You should see the following indications on the ST700 Dash Display System display:

- The dial illumination will turn on.
- The display backlighting will turn on.



If you have configured the ST700 Dash Display System for a low intensity of backlight, it might be difficult to see the above illumination features.

- The four shift lights and the alarm LED should show red briefly and then go off. Because it is possible to change the intensity of the shift lights it might be difficult to see these indications on the lowest intensity setting if the ambient light is very bright.
- The tachometer needle will move fully anticlockwise to reset against its stop. The needle will then settle on zero briefly and then move to the current engine speed (if the engine is running).
- The display will briefly show the version of software in use and will then show the speed layer.

If none of these indications appears when you power-on the system, consult the troubleshooting instructions starting on page 62. Contact Stack for advice if necessary using the contact details on page 75.

Changing the display layers

With the ST700 Dash Display System operating in its 'normal' mode, you will see a display similar to that shown in Figure 12. In the example shown, which features a '0-4-10500' dial face, the tachometer needle shows the engine is not running. The display is showing the odometer.



Because the measurement capabilities of the ST700 Dash Display System depend on the sensors and options supplied and fitted with your system, some of the following descriptions might not apply to the ST700 Dash Display System installed in your vehicle.

Measurement accuracy for speed, corner and straight speed, and odometer distance will depend on the correct settings made under WSPD Input, described on page 54.

Use the Driver button to cycle through the available display layers:

Display Layer 1 *This layer will always be active when you switch on the ST700 Dash Display System*



Layer 1 shows the odometer reading and the vehicle speed. Press the rotary control briefly to toggle the display between showing the total distance, and the trip distance.

With the trip distance on display, press the rotary control for between one and two seconds to reset the distance to zero.

Press the Driver button and the Rotary control together to arm the ST700 Dash Display System for use in hillclimb and sprint operations, described on page 42.

Press the Driver button to show Layer 2.

Display Layer 2 *It is possible to disable this display layer in setup mode*

A digital display showing the time 0:00.00 in a pixelated font. The digits are black on a light gray background.

Layer 2 shows the time recorded for the latest completed lap in minutes, seconds and hundredths (or minutes, seconds and tenths for times longer than 10 minutes).

Press the Driver button to show Layer 3.

Display Layer 3 *It is possible to disable this display layer in setup mode*

A digital display showing the text 'Hi' followed by a space and the digit '0'. The text is in a pixelated font, black on a light gray background.

Layer 3 shows the maximum Straight Speed. This is the latest value trapped by the ST700 Dash Display System for maximum speed reached along the straight.

Press the Driver button to show Layer 4.

Display Layer 4 *It is possible to disable this display layer in setup mode*



Layer 4 shows the minimum Corner Speed. This is the latest value trapped by the ST700 Dash Display System for the minimum speed reached while cornering.

The Corner Speed feature is a useful tool to help drivers improve their performance through a specific turn.

Press the Driver button to show Layer 5.

Display Layer 5 *If only one analogue channel is in use, this display layer will not be available*



Layer 5 shows the measurement made on analog channels 1 and 2. You may set these to show any of the measured channels of pressure or temperature. See Table 2 and Table 4 on page 23 and page 25.

Press the Driver button to show Layer 6.

Display Layer 6



Layer 6 shows the measurement made on analog channel 1, which you may set to any measured channel, and the battery voltage.

Press the Driver button to return to Layer 1 and the beginning of the sequence.

Pop-up Display Layers

The ST700 Dash Display System can supply information to the driver through several pop-up messages and alarms on the display as shown in Figure 13. The pop-up messages remain on display for a short, user-defined period. The alarms remain on display until the alarm condition disappears or until the driver cancels them.

You may set the time in seconds that the display shows each pop-up message from zero (meaning that pop-up messages never appear) to 99 seconds (meaning that the pop-up remains on display permanently). Refer to page 49 for instructions. When a pop-up message appears, three conditions will cancel it:

1. The pop-up message ‘times out’ at the end of its user-defined pre-set display period.
2. The ST700 Dash Display System overwrites an existing pop-up message with a new one that occurs before the ‘time out’ period elapses for the old message.
3. The driver presses the Driver button to cancel the pop-up message and return to the normal driver display.



It is important to distinguish between pop-up messages and alarm messages. Alarm messages will remain on display with the Alarm LED lit until the alarm is cancelled or until the alarm condition disappears.

Figure 13: Pop-up message examples

A digital display showing the lap time '1:23.47' in a large, bold, black font on a light gray background.

Lap time (always enabled) M:SS.ss...

A digital display showing the lap time '19:32.7' in a large, bold, black font on a light gray background.

...or M:SS.s if time is longer than ten minutes

A digital display showing split time 'S1 0:34.4' in a large, bold, black font on a light gray background.

Split time S1 and S2 (if enabled)

A digital display showing acceleration or deceleration time '8.43' in a large, bold, black font on a light gray background.

Acceleration or deceleration time (if enabled)

A digital display showing standing quarter mile time '1/4 17.51' in a large, bold, black font on a light gray background.

Standing quarter mile (if enabled)

A digital display showing a monitored condition alarm 'BV 9.6' in a large, bold, black font on a light gray background.

Monitored condition alarm

A digital display showing a memory low warning 'Memory Low 19Laps' in a large, bold, black font on a light gray background.

Lap memory has fewer than 20 spaces remaining

A digital display showing a lap memory full warning 'Lap time Memory Full' in a large, bold, black font on a light gray background.Lap memory is full

Lap and Split Times

The lap timing feature of the ST700 Dash Display System allows you to measure the following:

- Total time to complete each lap
- Split times for up to two locations on the track

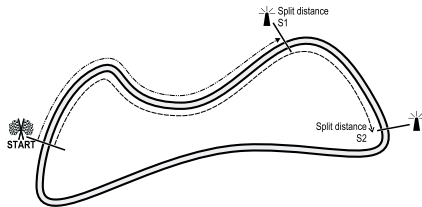

Figure 14: Lap timing

1. Lap timing starts when the vehicle passes the trackside infrared beacon or when the driver presses the Lap Timer button (if manual lap timing is fitted).
2. When the vehicle passes the beacon (or when the driver presses the Lap Timer button) again, the ST700 Dash Display System will display a pop-up message that shows the total time taken to complete the lap. At the same time it resets the timer to zero and starts to time the next lap.
3. The above process repeats for each lap. The ST700 Dash Display System records the times for the first 75 laps so that you may review them later. The display will show a warning message when you switch on the ignition if there is memory space for fewer than 20 laps remaining. It will indicate that the memory is full if there is no lap memory remaining.

You may use the Split timing feature to measure, display and record the time taken to complete sections of the circuit.

The reference point for both split times, S1 and S2, is the point where Lap timing starts as explained above. This means that, if you move the beacon, then both split points will move by the same distance also. It is also important to place the infrared beacon in the same place each time you visit a track so that the timing results are directly comparable from one visit to the next.



Note that split timing comes directly from the lap timing feature. Any errors in lap timing caused by inaccurate manual triggering by the driver will therefore degrade the split timing accuracy. Split timing errors could also arise from inaccurate wheel speed measurement.

The ST700 Dash Display System allows you to set split distances for S1 and S2 or for S1 by itself if you need only one split time per lap. You may set the split distances manually, or you may set them automatically as you drive the vehicle around the track.

After you configure the ST700 Dash Display System with split distances, it will start to measure distance around the track until it passes the S1 reference point. The display will then show the S1 pop-up message, for example:



This message will remain on display until one of the three conditions listed on page 35 cancels it.

When the ST700 Dash Display System determines that it has travelled to the second reference point S2, it will show the S2 pop-up message, for example:



Note that the split times shown by the pop-up messages are measured from the start of the lap. In memory review mode, S1 is the time from the start of the lap to the

first reference point and S2 is the time between the first and the second reference points.

Manual Split Timing Setup

To set the S1 and S2 split distances manually:



1. Enter the ST700 Dash Display System setup mode by pressing the rotary control for longer than two seconds.
2. When the display changes to allow memory review or setup, turn the control clockwise until it shows 'Performance Timers'.
3. Press the rotary control briefly so that the display shows 'Split Timing'.
4. Press the rotary control again to see the current setting for Split 1 distance, which will appear either in metres or feet according to user-defined preferences.
5. Press and turn the rotary control in either direction to adjust the Split 1 distance to higher or lower settings. You may change the set-

ting in larger steps if you hold the Driver button while you make this adjustment. Release the controls to set the Split 1 distance at the displayed value, which should be the distance from the lap reference point.

6. Turn the rotary control clockwise by one step to show the current setting for the Split 2 distance. This must always be equal to or larger than the setting for Split 1. Press and turn the rotary control to set the distance from the lap reference point to the second split timing point. Release the controls to set the Split 2 distance at the displayed value.
7. Return to the normal display mode:
 - Turn the rotary control clockwise to show 'Return To Last Menu'.
 - Briefly press the rotary control to show 'Split Timing'.
 - Turn the rotary control clockwise until it shows 'Return To Last Menu'.
 - Briefly press the rotary control to show 'Performance Timers'.
 - Turn the rotary control clockwise until it shows 'Exit Menus push button'.
 - Briefly press the rotary control to restore the normal operating mode.

Automatic Split Timing Setup

To set the S1 and S2 split distances automatically:

1. Enter the ST700 Dash Display System setup mode by pressing the rotary control for longer than two seconds.
2. When the display changes to allow memory review or setup, turn the control clockwise until it shows 'Performance Timers'.
3. Press the rotary control briefly so that the display shows 'Split Timing'.
4. Press and turn the rotary control to set the split setup to 'Enabled'.
5. Exit to the Run mode and the display will show 'Waiting for beacon'.
6. When the vehicle passes the beacon at the start of the lap the display will change to show the increasing distance covered as the vehicle moves around the track.
7. Press the Driver button as the vehicle passes the first split marker to set the distance and to start measuring the second split distance. The display will continue to show the increasing distance covered as the vehicle moves around the track.

8. Press the Driver button as the vehicle passes the second split marker to set the distance.

This procedure sets both split timing distances automatically. Follow the instructions on page 39 for setting the split timing distances manually if you then need to make any adjustments to these distances.

Use the automatic split timing setup feature to measure and set the split distances when you first visit and use a track. Before you leave the track, note the split distances and then enter these distances manually during future visits to the same track. This helps to ensure repeatability from one visit to the next.

Hillclimb and Sprint Operation

To remove the requirement for a beacon at the start line, your ST700 Dash Display System has an 'arming' feature. This allows you to set the ST700 Dash Display System so that it starts timing from the instant when the wheels begin to move. Your system must include a functioning wheel speed sensor to use this feature.

Press the Driver button and the Rotary control together from the normal display mode to arm the system. The next time the vehicle starts moving, the ST700 Dash Display System will record a lap mark. If the vehicle is already moving, the ST700 Dash Display System will wait for the speed to be zero.

You will still require a beacon at the finish line to give the end time.

MEMORY AND SETUP

This chapter describes the Memory Review and System Setup features of the ST700 Dash Display System. The diagram on the right shows the System Setup and the Memory review menus, which you may enter from the Run mode. The ST700 Dash Display System begins to operate in the Run mode after power-on.

To switch from the Run mode to the setup modes, press the rotary control for longer than two seconds and then release it when the display changes. Whatever the engine speed, the tachometer needle will move to a fixed position on the dial where it is not in the way of the display.

- ❑ The description of the memory review features that you may use to examine details of the laps recorded in the system memory starts below.
- ❑ Instructions to setup the ST700 Dash Display System begin on page 47.

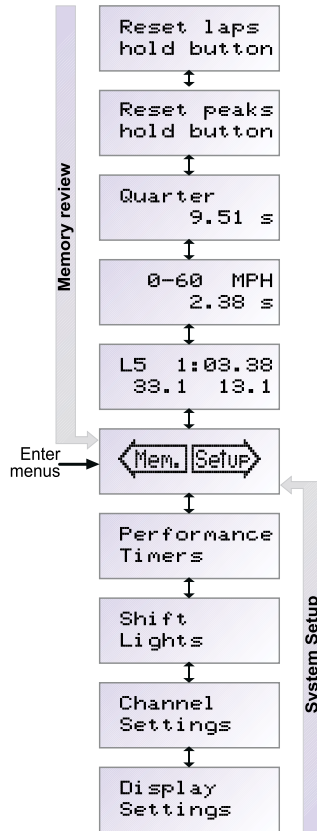

Memory and SetupST700 Dash Display System

- ❑ If you do not use the rotary control, the system will return to Run mode after five minutes. If the vehicle is moving, the system will return to Run mode after 30 seconds.
- ❑ From this display, turn the rotary control anticlockwise to use the Memory Review features described below, or clockwise to use the Setup menus described between page 47 and page 59.

Memory review features

Enter the Memory Review and System Setup mode as described above. Turn the rotary control anticlockwise to step through the memory review features described below.

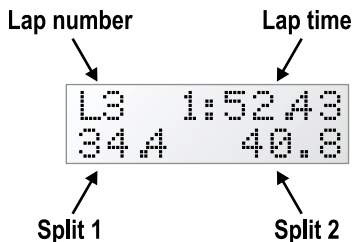

Lap timing—When you enter this mode, the display will show details for the most recent lap.

Note that the memory review for Split 2 shows the time *difference* between the two split markers. This is unlike the real-time display pop-up for Split 2, which shows the total time taken from the start of the lap to reach the second split marker.

Press and turn the rotary control to cycle through the lap memory, turning the control anticlockwise to review earlier laps. The ST700 Dash Display System can record lap and split times for up to 75 laps before the

ST700 Dash Display System Memory and Setup

lap memory becomes full. The ST700 Dash Display System will then continue to display lap and split times in pop-up messages, but will not record them to memory for subsequent review. Press the Driver button to show the fastest lap. Follow the instructions on page 46 to clear the lap memory.



0-60 MPH
8.69 s

Acceleration timing—The display shows the set points for the starting speed and the finishing speed together with the units used. In the example to the left, the display

shows a speed range from zero to sixty miles per hour. The display also shows the most recent time that it took for the vehicle to accelerate through the stated speed range. This information also appears in a pop-up message for the driver.

Follow the instructions on page 48 to alter the speed range for the acceleration timer and to enable or disable the pop-up message that shows this information. You may set a start speed that is higher than the end speed to use the ST700 Dash Display System as a deceleration timer.

If you press and hold the Driver button, the display shows the shortest acceleration or deceleration time recorded since you last reset the peak values.



Quarter
20.93 s

Quarter mile timing—The display shows the time taken to cover a quarter mile from a standing start. The timer will be triggered automatically whenever the vehicle

Memory and SetupST700 Dash Display System

starts to move. This information also appears in a pop-up message for the driver. Follow the instructions on page 49 to enable or disable the pop-up message.

Reset peaks—Press and hold the rotary control for longer than one second to reset all the peak values. This action will also clear the times for the acceleration and standing quarter mile measurements.



```
Reset peaks  
hold button
```

Reset laps—Press and hold the rotary control for longer than one second to reset all the lap and the split times. This action will clear the lap memory and will therefore clear the lap memory low or full warning pop-up.



```
Reset laps  
hold button
```

The system confirms the reset of peaks and lap timings after this action.

Turn the rotary control to 'Return to Last Menu', press it briefly and turn the control anticlockwise to show 'Exit Menus push button'. Press the rotary control briefly to return to the Run mode.

Setup mode



In the Setup mode, if you press the Driver button as you press and turn the rotary control, you will adjust some of the settings in larger steps.

Enter the Memory Review and System Setup mode as described on page 43. Turn the rotary control clockwise to step through the Setup features described below.

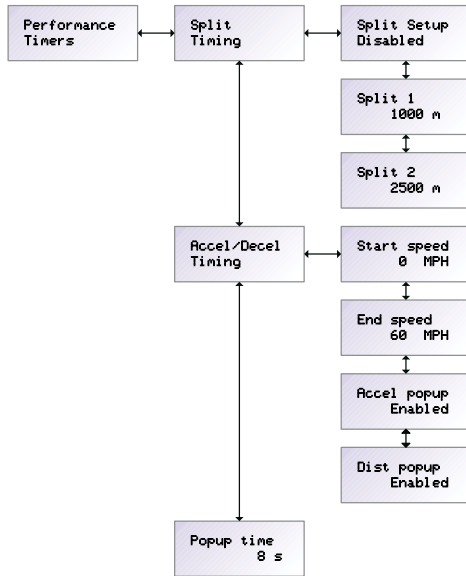

Performance timers—Press the rotary control when the display shows ‘Performance Timers’ to access the three menu items that allow you to set the split timing and acceleration timing functions and the pop-up settings.

□ **Split Timing**—Refer to page 37 for a description of lap and split timing. Turn the rotary control clockwise until the display shows ‘Split Timing’. Press the rotary control briefly to show the current setting for the first split timing dis-

Memory and SetupST700 Dash Display System

tance. This will appear either in feet or in metres, according to the settings you make for WSPD Input Measurement Units (page 54). Press and turn the rotary control to adjust the Split 1 distance. Release the control to set the Split 1 distance at the displayed value.

Turn the rotary control clockwise and then follow the procedure described above to set the Split 2 distance. Note that the Split 2 distance cannot be less than the Split 1 distance.

Turn the rotary control clockwise and then press it to return the display to show 'Split Timing'.

- Acceleration timing—Turn the rotary control clockwise until the display shows 'Accel/Decel Timing'. Press the rotary control briefly to show the current setting for the acceleration starting speed. Press and turn the rotary control to alter this setting. Release the control to set the acceleration start speed at the displayed value.

Turn the rotary control clockwise to show the current setting for the acceleration end speed. Press and turn the control to adjust this speed. Release the control to set the acceleration end speed at the displayed value. The system measures deceleration timing if the starting speed setpoint is higher than the end speed setpoint. If you set the start speed and the end speed to be the same, timing is disabled. Set the speed in the same units used to display speed measurements—MPH or km/h.

The ST700 Dash Display System will measure the time that it takes for the vehicle to accelerate or decelerate through the set speed

ST700 Dash Display System Memory and Setup

range. This information will be available in the memory review display, described on page 45. It will also appear in a pop-up message if you have selected this function as described below.

Turn the rotary control clockwise to show the current status of the acceleration timing pop-up. Press and turn the rotary control to enable or disable the pop-up. With the pop-up enabled, as soon as the vehicle passes the end speed set point the display will change to show the time taken to accelerate or decelerate through the set speed range. With the pop-up disabled, the display will not show this information.

Turn the rotary control clockwise to show the current status of the distance timing pop-up. Press and turn the rotary control to enable or disable the pop-up. With the pop-up enabled, as soon as the vehicle passes the quarter mile distance after moving from a standstill, the display will switch to show the time taken to cover this distance. With the pop-up disabled, the display will not show this information. This measurement is available in the memory review display.

Turn the rotary control clockwise and then press it to return the display to show 'Accel/Decel Timing'.

- Pop-up Settings—Turn the rotary control clockwise until the display shows 'Popup time'. Press the control briefly to show the current setting for the pop-up time. This is the time that any pop-up will remain on display until it times out. Press and turn the control to adjust the setting. Note that a setting of zero will disable all pop-

Memory and SetupST700 Dash Display System

ups. If you set the pop-up time to 99, pop-ups will remain on view until the Driver button is pressed.

Turn the rotary control clockwise and then press it to return the display to show 'Popup Time'. Turn the rotary control clockwise again and then press it to return the display to show 'Performance Timers'.

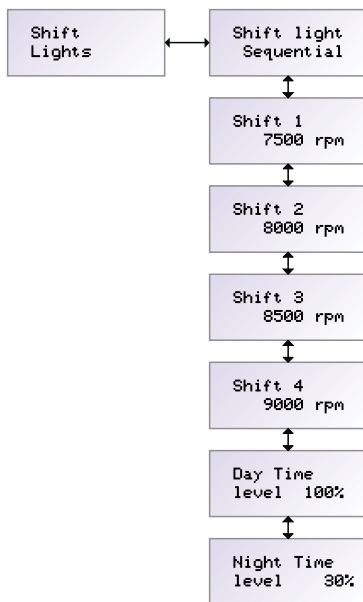

Shift Lights—Press the rotary control when the display shows 'Shift Lights' to access the six menu items that set the way the four shift lights on the display unit behave.

□ Shift light—Press and turn the rotary control to set the sequence of lights that will appear as the engine speed increases. Note that the choices of shift light sequence will depend on the options available on your system.

Figure 15: Shift light sequence as engine speed increases

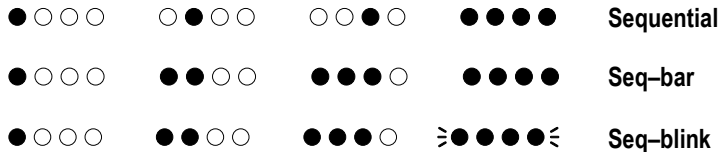

Disabled—The display unit will not show the shift lights as the engine speed changes.

Single—All four shift lights illuminate together when the engine speed reaches the set point for shift light 4 (the right-hand shift light).

Sequential—The shift lights illuminate singly in sequence from left to right as the engine speed reaches each set point, with all the lights showing when the engine speed reaches the set point for shift light 4.

Seq-bar—The shift lights illuminate in sequence, with each light adding to those already illuminated as the engine speed reaches each set point.

Seq-blink—The shift lights illuminate following the same sequence as ‘Seq-bar’, but they will all flash together when the engine speed reaches the set point for shift light 4.

Memory and SetupST700 Dash Display System

- ❑ Shift 1 to Shift 4—Press and turn the rotary control to set the engine speed that will illuminate shift light 1 (the left-hand shift light) to shift light 4. As you adjust the set point for each of the shift lights, the tachometer needle will move on the display to show the setting. Note that the ST700 Dash Display System always maintains the correct sequence so that the shift lights illuminate from left to right as the engine speed increases.
- ❑ Day Time level—Press and turn the rotary control to set the intensity of the shift lights for use during the day. Note that the LEDs used in the display are high intensity devices so that it will be possible to see them even when the ambient light is very strong. Refer to page 29 for instructions to switch between the daytime and the night-time levels for display and shift light illumination.
- ❑ Night Time level—Press and turn the rotary control to set the intensity of the shift lights for use during the night.

Turn the rotary control clockwise and then press it to return the display to show 'Shift Lights'.

ST700 Dash Display System Memory and Setup

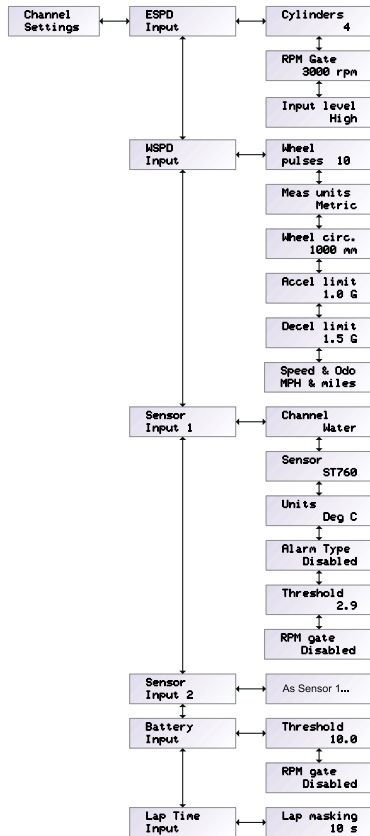

Channel settings—Press the rotary control briefly when the display shows ‘Channel Settings’ to setup the input channels to the ST700 Dash Display System. Press and turn the control to move among the channel settings sub-menus.

❑ **ESPD Input (Engine speed)**— Press the control briefly to see the current setting for the number of cylinders in the engine. Press and turn the control to adjust this setting to match the number of cylinders in the vehicle’s engine. For two-stroke engines, set this value to twice the number of cylinders (for example, set the value to 4 for a two-cylinder two-stroke engine, or 6 for a three-cylinder two-stroke engine—see the troubleshooting heading on page 67).

RPM gate—Pop-ups will appear on an alarm condition only when the engine speed is above the gate RPM setting—there will be no alarm pop-

Memory and SetupST700 Dash Display System

ups when the engine speed is below this setting. This is to prevent the occurrence of alarm pop-ups when the engine starts and measured conditions such as the oil pressure will be low for a short period. Press and turn the rotary control to adjust the gate RPM setting.

Input level—Press and turn the rotary control to set the system for a high level or a low level signal for the engine speed input. Your choice will depend on the source of the signal. Typically the setting will be ‘high’ if the signal comes from a coil or a magneto, and ‘low’ if it comes from an ECU ‘tacho’ output.

- ❑ WSPD Input (wheel speed)—Press the control briefly to see the current setting for the pulses that the wheel speed sensor detects for each wheel rotation. Press and turn the rotary control to adjust this setting, which will depend on the specific installation details. Refer to page 21 for instructions to install the wheel speed sensor.

Meas units—Press and turn the control to set the ST700 Dash Display System to measure in metric units or in imperial units. This setting affect the measurement units to set the split timing distances (either in feet or metres) described on page 39, and the wheel diameter setting (in inches or millimetres) described below. It does NOT affect the units used to display speed or odometer distance, which depend on the choice you make under ‘Speed & Odo’ described on page 56.

Wheel circ—Press and turn the rotary control to adjust the setting of the wheel circumference. The ST700 Dash Display System uses this

ST700 Dash Display System Memory and Setup

measurement, together with the number of pulses, to calculate and display the vehicle speed and the odometer distance. The accuracy with which you measure this value has a direct influence on the accuracy of the speed and distance measurements.

Accel limit—Press and turn the rotary control to adjust the acceleration limit setting, which prevents the ST700 Dash Display System responding to apparent extremes of acceleration caused, for example, by wheel spin. If wheel spin occurs on the wheel that has the wheel speed sensor, the speed reading from the sensor will step almost instantaneously to a much higher level. This would give errors in the measurement of distance and split times. To avoid this, the ST700 Dash Display System allows you to set the maximum acceleration so that it then filters the signal to give more accurate indications of speed and distance.



Unless you have access to a reliable method for measuring acceleration, you should set this value experimentally. For guidance, an acceleration of 1G applied for 3 seconds will accelerate the vehicle from zero to 106 km/h or 66 MPH.

Decel limit—This function works in a similar way to the acceleration limit described above, but applies for deceleration. It prevents the displayed speed from instantaneously reducing if the wheel that includes the speed sensor locks during heavy braking, for example.

Memory and SetupST700 Dash Display System

Speed and odo—Press and turn the control to choose between using MPH and miles or Km/h and kilometres for the displays of speed and odometer distance.

- ❑ Sensor Input 1 and Sensor Input 2—The ST700 Dash Display System can display measurements made by up to two Stack sensors fitted to the vehicle. The information from these sensors appears on one of the display layers (see page 34). Press the rotary control briefly to set Sensor 1 or Sensor 2 to the correct measurement type. Refer to Table 2 on page 23 and Table 4 on page 25 respectively for the compatible types of Stack pressure and temperature sensors.

For each channel, set the measured parameter and then turn the rotary control to select the sensor type fitted and the units that the system will use to display the measurements.

You may also set the alarm type for each measured channel. Select disabled if you do not wish to set an alarm on a channel.

Set 'Above' to display a pop-up alarm when the measured condition goes above the threshold setting that you define (for example, when you monitor water temperature).

Set 'Below' to display a pop-up alarm when the measured condition goes below the threshold setting that you define (for example, when you monitor oil pressure).

Set a threshold value for the alarm setting. *The option to set a threshold will not be available if you have disabled the alarm feature.*

ST700 Dash Display System Memory and Setup

Select whether the RPM gate, described on page 53, is enabled or disabled.

- ❑ **Battery Input**—Press the rotary control briefly to see the current setting for the battery alarm. Press and turn the control to set the battery voltage below which the alarm pop-up will appear. You may also set the RPM gate for the battery voltage alarm.
- ❑ **Lap Time Input**—Press the rotary control briefly to see the current setting for Lap Masking. Press and turn the control to adjust the setting. You will disable the lap masking feature if you set the value to zero.

The infrared lap timing system supplied by Stack uses a coded infrared frequency that is common to all Stack lap timing systems. This feature allows users of Stack systems to share a common beacon at each circuit, and ensures that the ST700 Dash Display System will not be triggered by other manufacturers' timing beacons.

The lap masking feature allows you to make certain that your system does not pick up signals from incorrectly placed Stack beacons that could trigger a false lap time. Typically, you should set the lap masking time to 50% of an anticipated lap time.

Memory and SetupST700 Dash Display System



It is important that you are aware that your beacon can be picked up by other Stack systems and can affect their lap times if you set up your beacon mid-session. Therefore, for the convenience and out of respect to other users, you should not set up your beacon when cars are running. You should also consider cooperating with other users of Stack systems and use only one beacon at the circuit, although the different sensor heights on vehicles might require more than one beacon.

Display settings—Press the rotary control briefly when the display shows ‘Display Settings’ to set the illumination and contrast levels, and to set the lap time and corner speed layers.

- ❑ Night illumination level— Press the rotary control briefly when the display shows ‘Night illum level’ to see the current setting for night illumination level. Press and turn the control to set the level in the range 10% to 100%. The display will dim to show the current setting.

- ❑ Contrast—Press the rotary control briefly when the display shows ‘Contrast’ to see the current setting for display contrast. Press and

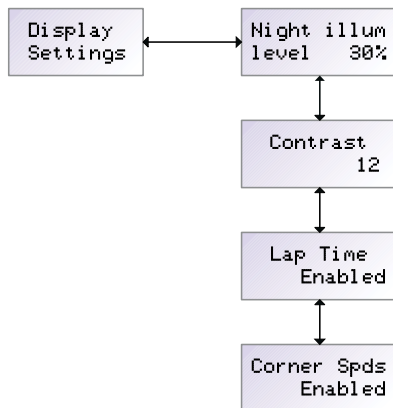

ST700 Dash Display System Memory and Setup

turn the control to adjust the contrast setting in the range 0 to 31. Settings at either extreme of this range will be difficult to see. Experiment with the control to find the ideal setting.

- ❑ Lap timing layer—Press the rotary control briefly when the display shows ‘Lap Time’ to see whether the lap timing layer is currently enabled or disabled. Press and turn the control to change the setting.
- ❑ Corner speed layer—Press the rotary control briefly when the display shows ‘Corner Spds’ to see whether the corner speed layer is currently enabled or disabled. Press and turn the control to change the setting.

Turn the rotary control clockwise and then press it to return the display to show ‘Display Settings’. Turn the rotary control clockwise and press it again to show ‘Exit Menu push button’. Press the control again to exit the setup mode and to restore normal operation.

TESTING

After you have installed and set-up the system as described in this manual, you should test it to make certain all the sensors, displays and alarm functions work correctly:

1. Switch on the vehicle ignition and check that the ST700 Dash Display System initialises correctly as described on page 31.
2. Start the engine and let it warm at idling speed. Check that the tachometer display shows the correct reading for the engine idling speed. If the tachometer shows a value that is completely wrong, you may have set the engine cylinders incorrectly. Refer to page 53 for instructions to set the number of cylinders.
3. Accelerate to a constant, safe speed, and time the vehicle between two markers whose separation distance you know. Calculate the vehicle speed and confirm that it is as shown by the ST700 Dash Display System. Any difference between the actual vehicle speed and the displayed value could be caused by one of two factors:
 - You have set the Wheel Pulses parameter incorrectly. Refer to page 54 for instructions to set the wheel pulses.
 - You have measured or set the Wheel Circumference parameter incorrectly. Refer to page 54 for instructions to set the wheel circumference.

Table 6: Time to cover measured distances at various speeds

Speed (MPH)	Speed (km/h)	Time (secs) 1 mile	Time (secs) 1000 metres
30	48.28	120	74.56
37.28	60	96.56	60
40	64.37	90	55.93
43.49	70	82.78	51.43
50	80.47	72	44.74
55.92	90	64.38	40
60	96.56	60	37.28
62.14	100	57.93	36
70	112.56	51.43	31.96
74.56	120	48.28	30
80	128.75	45	27.96

MAINTENANCE

The ST700 Dash Display System is a fully sealed unit that has no wearing or consumable parts. The unit requires no maintenance after installation. You will break the seals essential to keep the instrument waterproof and invalidate the product warranty if you remove the rear cover of the ST700 Dash Display System instrument.

Troubleshooting

If you experience problems with your ST700 Dash Display System, please check the following:

Display is dead

There is no backlight. Nothing appears on the display and there are no blue dial lights.

- Ignition is off
Turn ignition on.
- Battery is dead
Recharge or renew the battery.
- Power connection to B+ or B- is faulty
Check if the battery is connected correctly. Check continuity of the power leads.

The power lead is labelled **B+** and **B-**. The battery positive lead **B+** is on pin 1, and the battery negative **B-** is on pin 2 of the 8-way connector.

Display is dead

There is no backlight. Nothing appears on the display. The blue dial lights are on but appear dim. The 'Battery low' warning pop-up may appear on the display.

- Battery is almost dead
Recharge or renew battery.
- Power connection to B+ or B- is faulty
Check power lead continuity.

Display flashes and dial pointer resets or vibrates

- Battery is almost dead
Recharge or renew the battery.
- Power connection to B+ or B- is faulty
Check power lead continuity.

Display and dial show fixed high values

- Driver button (peaks) faulty

Renew the Driver button.

Disconnect the Driver button. If values return to normal, renew the button.

- Faulty switch wiring

Check the switch wiring.

Check wiring for a short between pin 8 and pin 2 (B-) of the 8-way connector.

Driver button: 'Show Peak Values' function does not work.**'Change display layer' function does not work.**

- Driver button faulty

Renew the Driver button

Disconnect the Driver button and short pins 1 and 4 together on the connector 'S1' to the tacho. If the display changes, renew the Driver button. Otherwise, check the wiring.

- Faulty switch wiring

Check the switch wiring for correct continuity

Pin 8 of the 8-way connector to pin 1 of the S1 connector should be approximately 6k8 ohms. Pin 1 of connector S1 to B- (chassis) should be greater than 1M ohms.

Rotary Control button: 'Enter Setup Mode' does not work.

- Rotary Control faulty
Renew the Rotary Control

Disconnect the Rotary Control and short together Pins 3 and 4 on the connector 'RC' for more than 2 seconds. If the display changes, renew the Rotary Control. Otherwise, check the wiring.

- Faulty Rotary Control wiring
Check the Rotary Control wiring for correct continuity

Pin 8 of the 8-way connector to pin 1 of the 'RC' connector Pin 1 should be approximately 10k ohms. Pin 1 of the 'RC' connector to B- (chassis) should be greater than 1M ohms.

- Rotary Control clockwise or anticlockwise turns do not change menu items.
Fit a new Rotary Control.

Lap time is not displayed automatically

- Lap marker receiver lead faulty
Check the lap marker wiring
- Lap marker receiver faulty
Renew the lap marker receiver

Disconnect the receiver and short together pins 1 and 4 on the 'LapT' connector. If the display changes, renew the receiver after checking its wiring.

- Trackside transmitter signal swamped by an adjacent transmitter.

Move the transmitters so that they are at least 4 metres apart.

- Trackside transmitter obscured by pit board.

Reposition the transmitter or the pit board.

- Trackside infrared transmitter is not working

Connect or charge the transmitter battery

Check for a green light on the side of the transmitter

- Incorrect alignment of transmitter and/or receiver

Re-align the transmitter and/or the receiver

Follow user guide instructions for setup

- Transmitter positioned with the sun at a low angle behind it

Move the transmitter to face into the sun

- Water on transmitter lenses

Remove water from the lenses. Fit a protective cover.

Shield lenses with a cover in all wet conditions.

Extra laps displayed. Lap times are too short.

- More than one transmitter around the circuit
Remove all but one transmitter from the circuit.

Increase the Lap Masking period.

Display values and messages unclear or unreadable (poor contrast)

- Display too hot or too cold
Ensure that the display operates within its specified temperature range
Operating temperature range is -20°C (-4°F) to $+70^{\circ}\text{C}$ ($+158^{\circ}\text{F}$)
- Incorrect contrast setting
Enter the setup mode and re-adjust the display contrast value

Tachometer value too high or too low by a constant %-age amount

- System configured with wrong number of engine cylinders
Reconfigure the system to the correct number of cylinders.
- The vehicle is using a 2-stroke engine
Set the number of cylinders to twice the actual number.
For example, a 2-cylinder 2-stroke engine requires the number of cylinders to be set to 4.
- Ignition system pulses per revolution not the same as the number of cylinders

Reconfigure the system to the correct number of pulses per revolution.

Ignition systems may use multiple coils where each additional coil gives proportionately fewer pulses per revolution.

Tachometer reading erratic, pointer jumps high or low

- Incorrect wiring

Reconnect the tachometer as specified in this manual

- Signal not intended to drive a Tachometer

Check for a more suitable connection point.

Use the ECU tachometer output signal in preference to the coil negative.

No Tachometer reading

- Incorrect wiring

Check the connection of the engine speed wire to the ignition system (or sensor, if used)

See the instructions supplied in this manual. If connected directly to the coil, check that it is to the switched low tension side (usually the negative side).

- Signal not suitable to drive a Tachometer

Signal from ignition or ECU is only 5V. Select the low engine speed threshold in the menu structure—see page 54.

Check for a more suitable connection point, such as the coil negative signal.

- ❑ ECU or ignition system output requires a 'pull up' resistor to be fitted

Fit a 1k0 ohm (1000 ohms) resistor from the ECU/ignition to Tacho lead, to Battery positive B+

Important: Check with the ECU/Ignition system manufacturer that this will NOT damage their system.

Displayed speed value too high or too low by a constant %age amount.

- ❑ System configured with wrong number of targets per wheel revolution

Reconfigure the system with correct values.

- ❑ System configured with the wrong wheel circumference

Reconfigure the system with correct values.

Typical wheel circumference is 1800mm (70 inches) for a car or 900mm (35 inches) for a kart

No speed reading. Speed reading erratic, value jumps high or low.

- ❑ Faulty sensor and/or wiring

Check the sensor indicator for correct operation.

Rotate the wheel by hand and check that the sensor indicator lights up as each target passes the sensor

- ❑ Incorrect sensor gap (too far or too close)

Check that the gap is approximately $1\text{mm} \pm 0.5\text{mm}$.

- ❑ Sensor and targets moving apart

Fabricate a more rigid sensor bracket

Speed reading dies after a short time

- ❑ Ambient temperature is too high

Shield the sensor from radiated heat from brakes and bearings. Use fibre washers to insulate the sensor from conducted heat. Duct cooling air around the sensor.

Maximum temperature for correct operation of the wheel speed sensor is $+80^{\circ}\text{C}$ (175°F)

Display works OK until engine starts then Display freezes or resets continuously. Display recovers once the engine stops.

- ❑ Interference from ignition system and HT leads

Fit suppressed (Silicon) HT Leads. Fit a suppression capacitor ($2.2\mu\text{F}$) between the coil (battery connection) and chassis. Check the capacitor on the distributor points system—fit a new capacitor if necessary.

Use 'Helical' suppressed leads in extreme cases.

- ❑ ST700 Dash Display System wiring is too close to the HT leads and/or injector leads, or the HT leads are tied to isolated metal work to which the system wiring is also tied.

Run wiring away from HT leads and injector leads

Recommended minimum spacing is 75mm (3.0 inches)

Needle dances up and down, lap times appear and speed is shown when the vehicle is stationary.

- ❑ The ST700 Dash Display System is in Demonstration Mode.
Set the correct number of cylinders, by following the instructions on page 53, to turn off Demonstration Mode.



You can restore the ST700 Dash Display System to its factory settings by pressing the Driver button and the Rotary control together, and then switching on the ignition. This also clears the lap and split timings, and resets all the peak readings.

After you restore the factory settings, the Demonstration Mode will be activated. To turn off the Demonstration Mode, set the correct number of cylinders as instructed on page 53.

Specification**Physical and environmental**

Size	Front of dash	88mm Ø × 8mm (3.5" Ø × 0.3")
	Behind dash	80mm Ø × 68mm (3.15" Ø × 2.7")
	Overall	88mm Ø × 76mm (3.5" Ø × 3.0")
Mounting	Hole	80mm (3.15") diameter
	Rear clearance	90mm (3.5")
Fixing thread		2 × M4 × 1.5 × 20L (7.0 AF ~ 9/32" AF)
Power		8 to 18VDC 200mA typ 500mA max Internal auto-reset 500mA fuse
Weight		500g (1.1 pounds) including harness
Temperature	Operating	-20°C to +80°C (-4°F to 176°F)
	Storage	-30°C to +90°C (-22°F to 194°F)
Vibration resistance		15G 50Hz to 2kHz 12Hr 3 × axis (36 Hr total)
Shock resistance		500m/s (30ms)
		1600ft/s (30ms)
Sealing		IP67
Humidity		0 to 95% RH non-condensing
EMC		EN50081-2

Performance

Engine speed	Accuracy	$\pm 0.4\%$ (non-linear dials) $\pm 0.6\%$ (linear dials)
	Range	400 to 32000 RPM
	Cylinders	1 to 16 (4-stroke)—1 to 8 (2-stroke)
	Input	Coil negative, Magneto or ECU Tacho pulse output
	Max input frequency	2500 Hz
Wheel speed	Accuracy	$\pm 0.25\%$ (MPH and km/h)
	Range	3 to 250 MPH (5 to 480 km/h)
	Pulse per revolution	1 to 99
	Wheel circumference	400mm to 5m (16.0" to 200.0")
	Max input frequency	2500 Hz
Sensor accuracy	Resistive	1.0% max (0.4% typ) + sensor accuracy
	Voltage	2.0% max (1.0% typ) + sensor accuracy
Sensor resolution	Pressure	± 0.1 Bar or ± 1 PSI
	Temperature	$\pm 1^{\circ}\text{C}$ or $\pm 1^{\circ}\text{F}$ in the range 0°C to 110°C (32°F to 230°F)
Battery voltage	Accuracy	0.3V max (0.1V typ) ± 1 digit
Peak (max/min) recall		On all displayed parameters. User resettable.
Lap time accuracy		10ms ± 1 digit

Maintenance **ST700 Dash Display System**

Split time accuracy	$\pm 0.1s \pm 1$ digit
Laptime memory	75 laps of $1 \times$ lap + $2 \times$ split times
Acceleration timer accuracy	$\pm 0.1s \pm 1$ digit
Quarter mile timer accuracy	$\pm 0.1s \pm 1$ digit
Corner speed accuracy	$\pm 0.25\% \pm 1$ digit
Dial back light	Use adjustable blue LED with night and day settings
LCD back light	Use adjustable green LED with night and day settings
Display format	15×66 pixel graphic. One line 5×9 mm height, or Two lines 11×4.5 mm height
Dial connections	8-way Switchcraft sealed plug Mating part 8-way Switchcraft EN3C8F20C
	6-way Switchcraft sealed plug Mating part 6-way Switchcraft EN3C6F20C
Harness connections	4-way Sure Seal (ITT Canon) plug and receptacle

Contact details

The contact details for Stack are:

UK and International

Stack Limited
Wedgwood Road
Bicester
Oxfordshire OX 26 4UL
UK

Tel: +44 (0)1869 240404
Fax: +44 (0)1869 245500

e-mail: sales@stackltd.com
e-mail: support@stackltd.com
www.stackltd.com

USA and North America

Stack Inc.
3545A Cove Creek Court
Cumming
Atlanta
Georgia GA 30040
USA

Tel: (888) 867 5183
Fax: (888) 364 2609

e-mail: sales@stackinc.com
e-mail: support@stackinc.com
www.stackinc.com

Figure 16: Wiring diagram—8-way harness

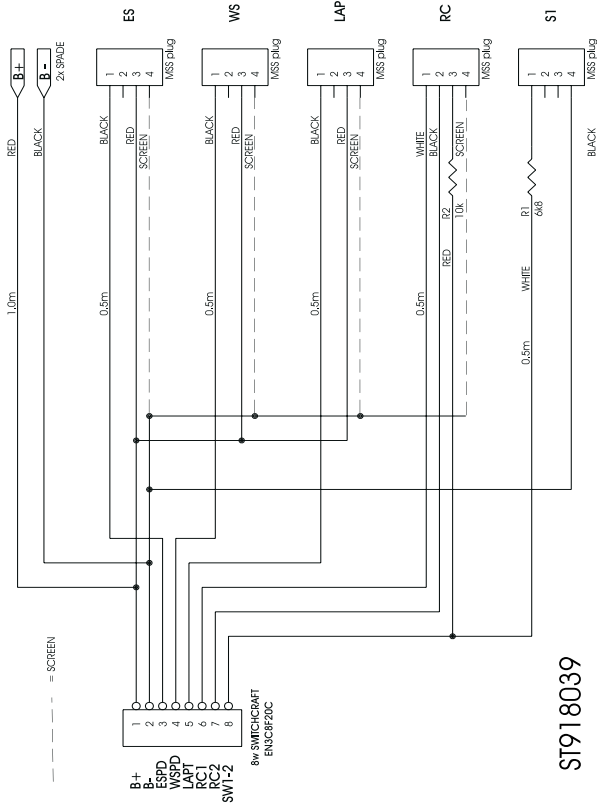
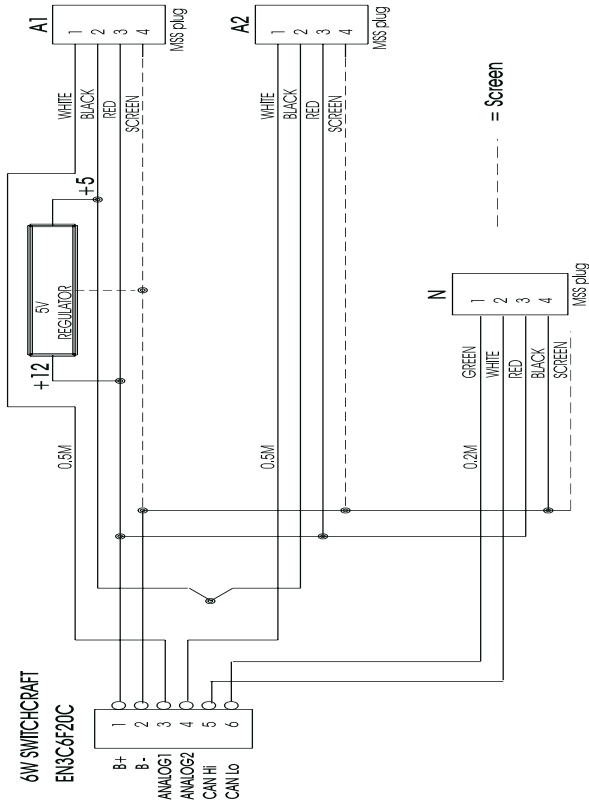

Figure 17: Wiring diagram—6-way harness



Index

Numerics

2–stroke engines **53**

A

acceleration limit **55**
acceleration timer **45**
 peaks **45**
acceleration timing
 pop–up **49**
alarm threshold **56**

B

battery alarm **57**

C

channel settings **53**
 RPM gate **53**
 wheel speed **54**
contrast **58**
controls **13**
 driver button **28, 35**
 lap timing button **20**
 rotary control **28**
corner speed **34**

cylinders **53**

D

deceleration limit **55**
deceleration timing **48**
demonstration mode **71**
display contrast **58**
display illumination **29**
distance timing
 pop–up **49**
distance units **56**
driver button See controls

E

engine speed **53**

H

hillclimb **42**

I

ignition systems **15**
illumination **29**
infrared beacon **16, 18, 37**
 lap masking **57**
 moving **38**
Initialisation **31**

- installation **8**
 - display unit **8, 12**
 - engine speed measurement **14**
 - infrared beacon **18**
 - lap timing button **20**
 - lap timing sensor **16**
 - power **27**
 - pressure sensors **23**
 - temperature sensors **25**
 - wheel speed sensor **21**
 - wiring harness **9**
- IR beacon See infrared beacon
- L**
 - lap button See controls
 - lap masking **17, 57**
 - lap review **44**
 - lap timing **16, 33, 37**
 - lap masking **57**
 - manual control **20, 37**
 - reset **46**
- M**
 - measurement units **54**
 - memory review **30, 43, 44**
- split times **39**
- O**
 - odometer **32**
 - reset **32**
 - odometer units **56**
 - operating modes **30**
- P**
 - peaks
 - reset **46**
 - performance timers **47**
 - pop-up layers **35**
 - power-on **31**
 - pressure sensor **23**
- R**
 - reset factory settings **71**
 - reset lap timing **46**
 - reset peaks **46**
 - rotary control See controls
 - RPM gate **53**
- S**
 - sensors **23, 25**
 - setup mode **30, 43**

- performance timers **47**
- shift light **50**
- speed display **32**
- speed units **56**
- split timing **37–40, 47**
 - manual setup **39**
 - memory review mode **39**
- sprint **42**
- standing quarter mile **45, 49**
- system setup See setup mode

T

- temperature sensor **25**
- two–stroke engines **53**

W

- wheel circumference **54**
- wheel speed
 - acceleration limit **55**
 - deceleration limit **55**
- wheel speed sensor **21, 54**
- wiring harness **9**

Published by Stack Limited
Wedgwood Road
Bicester
Oxfordshire OX26 4UL
England